



NRG: Solid state relays with real-time monitoring

Switches

NRG series

Digital solid state relays

In order for machine builders to make informed decisions, solve urgent problems on short notice and develop machines that are more autonomous, data from the various components within the machine needs to be collected and analysed. The **NRG** has been developed to fit this purpose. Through the added communication interface, the solid state relays (SSRs) can exchange data with the machine controller in real-time. The switching of the SSRs can be controlled through this communication interface.

The **NRG** is a platform consisting of bus chains. Each bus chain is made up of an NRG controller daisy chained to a number of SSRs. The NRG controller interfaces with the machine controller (or PLC) and is available in Modbus RTU, Modbus TCP, PROFINET, EtherNet/IP™ or EtherCAT.

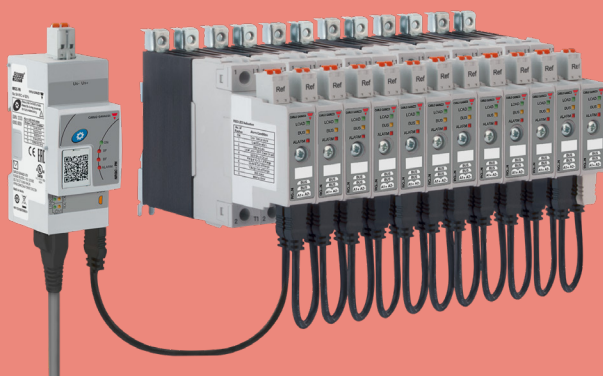
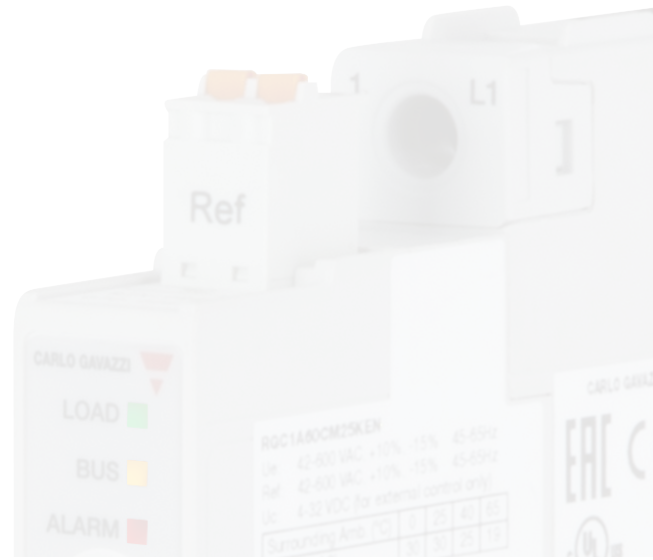

EtherNet/IP



EtherCAT

Reduced unplanned downtime with real-time monitoring

Predictive and better preventive maintenance plans

Condition based monitoring is essential to reduce unplanned machine stoppages. The NRG Load deviation alarm alerts of potential load failures prior to these happening. The SSR and Load running hours data helps maintainers schedule better preventive maintenance plans.

Versatility and flexibility

Monitoring solutions external to the SSR are limited in the data they can provide. The NRG provides a much more complete status that enables process improvements and can also be used to optimise energy management plans.

Precise temperature control

Specific applications may necessitate a very fine switching resolution. With power control mode a 1% resolution is possible, whilst with ON/OFF mode, SSRs can be switched every half mains cycle.

Panel space savings

With integrated switching, monitoring and diagnostics in the smallest solid state relay platform on the market, the NRG solution saves on valuable panel space. Compared to other monitoring solutions it eliminates the need of external current transformers, PLC analogue and digital cards.

Time labour savings in wiring

In the NRG system, all data transfer, error monitoring as well as load switching is done via the communication network thus eliminating all the extensive wiring required to connect external monitoring components and PLC cards.

Ready for IIoT

Through digitalization, machines can be accessed from any remote location. The communication interface on the NRG enables remote access down to the SSR level.

Applications

The NRG is the ideal switching solution when monitoring of the field level devices is required to minimise expensive downtimes. In addition to the switching function, the NRG integrates monitoring circuitry, in the same footprint, to enable exchange of data with the machine controller. The NRG solid state relays are suited for heating applications. Typical applications include:

- Plastic injection machines
- PET blow moulding machines
- Packaging machines
- Semiconductor manufacturing machinery
- Glass tempering machines



Digital solid state relays tailored for an IIoT environment

The industrial automation industry is at the outset of a new era of innovation with the hype of Industry 4.0. Data is at the core of this revolution and the NRG system of solid state relays fits right in the digital thread of information. On top of switching capabilities, the NRG digital solid state relays can

exchange monitoring and diagnostic data with the machine controller via the communication interface. This data can be further processed and analysed in a cloud system which would inflict a new horizon of opportunities for enhanced process automation, optimisation and part quality.

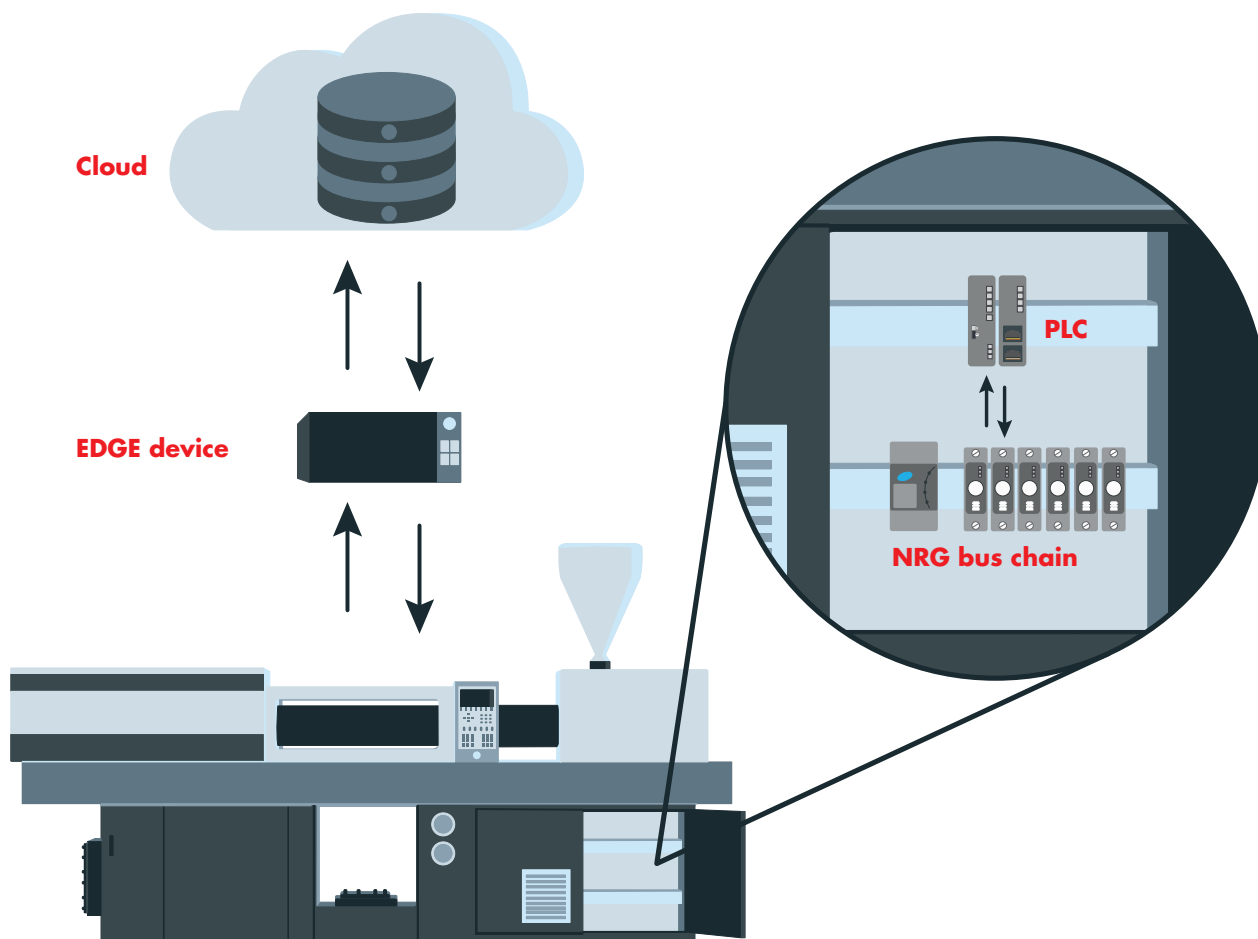

NRG series

An all-in-one cost-effective switching and monitoring

Compact

Minimum product width of 17.8 mm for a 37 AAC SSR that integrates both switching and monitoring

Data

A number of parameters accessible in real-time from each SSR enable process improvements

Connectivity

Use of common industrial protocols enable easy integration in industrial machinery

Reduced hardware

No additional components for monitoring; the bus eliminates PLC output and input cards

Flexibility

Various power control modes are available for all application requirements

Predictive maintenance

Possible via SSR running hours and Load resistance monitoring

Quick setup

Automatic addressing of all solid state relays on the NRG bus chain

Fast troubleshooting

Detailed system and network fault analysis via the communication system

Common

Available in: PROFINET, Modbus



ing solution

unication

RTU/TCP, EtherNet/IP™, EtherCAT

Switching

Up to 90 AAC, 600 VAC

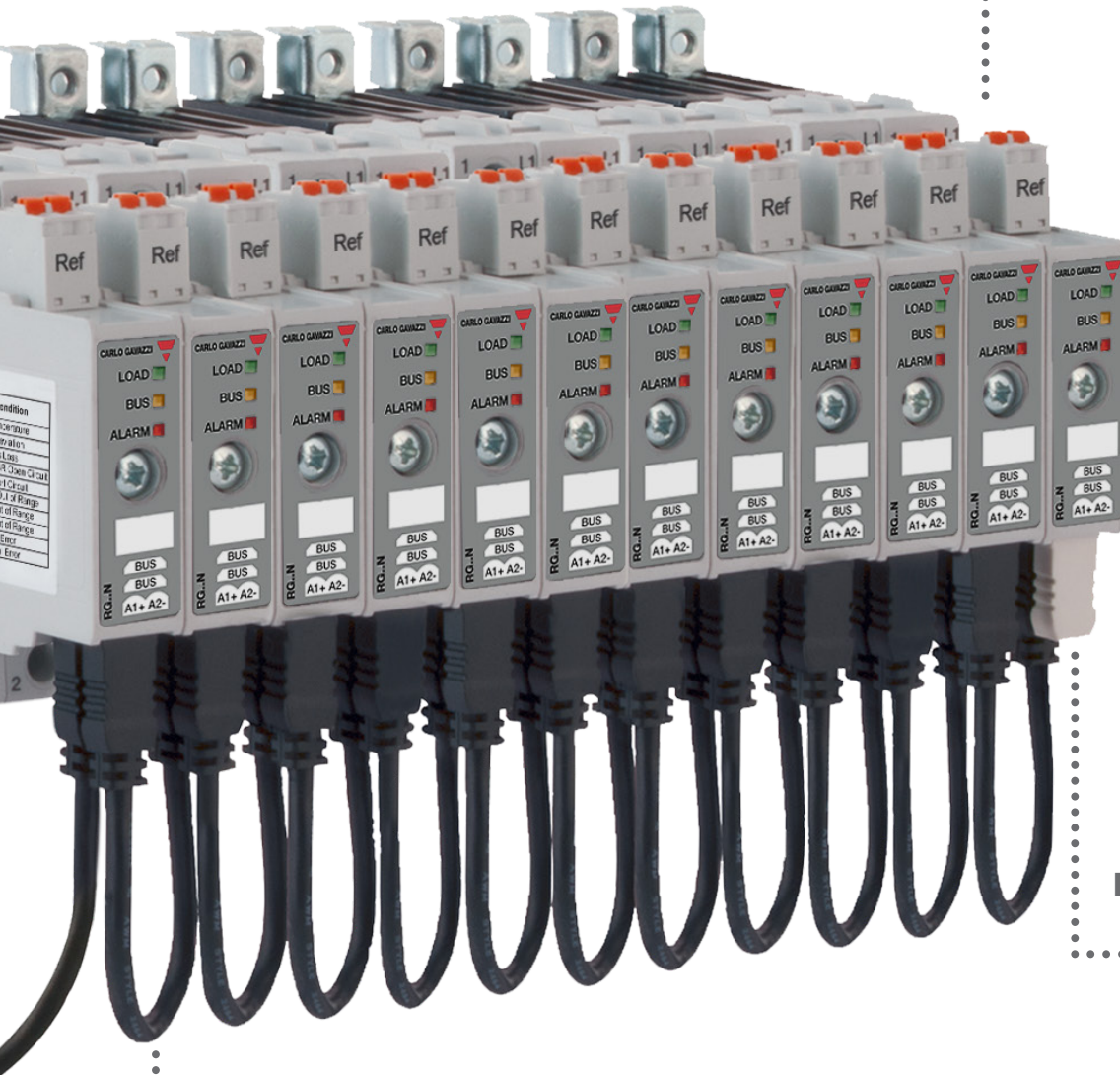

Diagnostics

Immediate system and SSR fault detection

Real-time monitoring

of Current, Voltage, Power,
Energy consumption and Running hours

NRG series

Features

The NRG bus chain components

The NRG is a sub-system that consists of one or more BUS chains that interact with the main controller or PLC in the machine via the communication interface. The NRG bus chain can have a maximum of 32 NRG solid state relays. The communication link between the NRG controller and the relays is the Internal BUS.

When more solid state relays are needed in a system, multiple BUS chains can be utilised. Standard protocol topologies can be adopted depending on the communication interface in use.

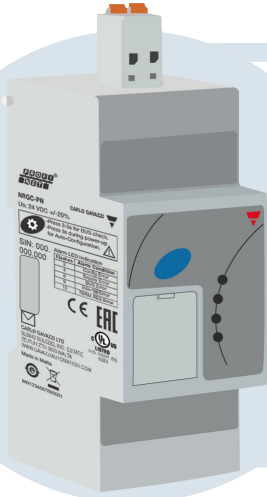

NRG Controller

The NRG controller is the main interface between the PLC and the NRG solid state relays. The NRG also performs internal operations related to the setup and maintenance of the NRG bus chain as well as monitoring the communication status. To facilitate communication via different communication protocols, the NRG Controller is currently available with a Modbus RTU interface for serial networks, PROFINET, EtherNet/IP™, EtherCAT or Modbus TCP for ethernet based networks.

NRG Solid State Relays

The NRG solid state relays are the switching devices that integrate monitoring circuitry and a communication interface through which measurement data and diagnostics can be exchanged with the machine controller. They are available with and without heatsink. Each NRG solid state relay on the bus chain is uniquely identified and automatically addressed on initial start-up.

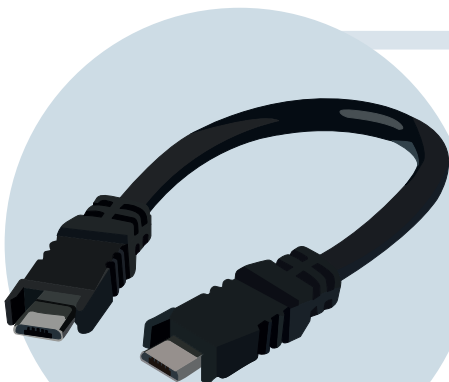
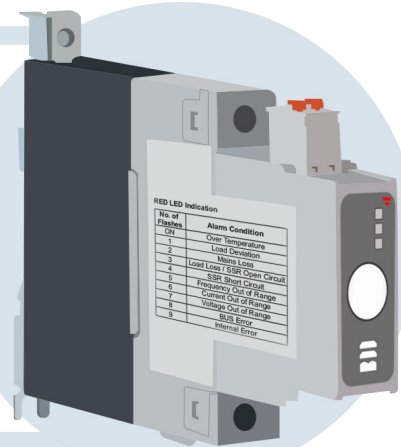

NRG Bus Cable

The NRG bus cable is a 5-way proprietary cable used for the internal BUS between the NRG controller and the NRG solid state relays on the bus chain. Apart from the data and supply lines, the NRG cable is equipped with an additional wire utilised for the auto-addressing of the NRG solid state relays on the bus chain.

Monitoring and load switching - A traditional system setup

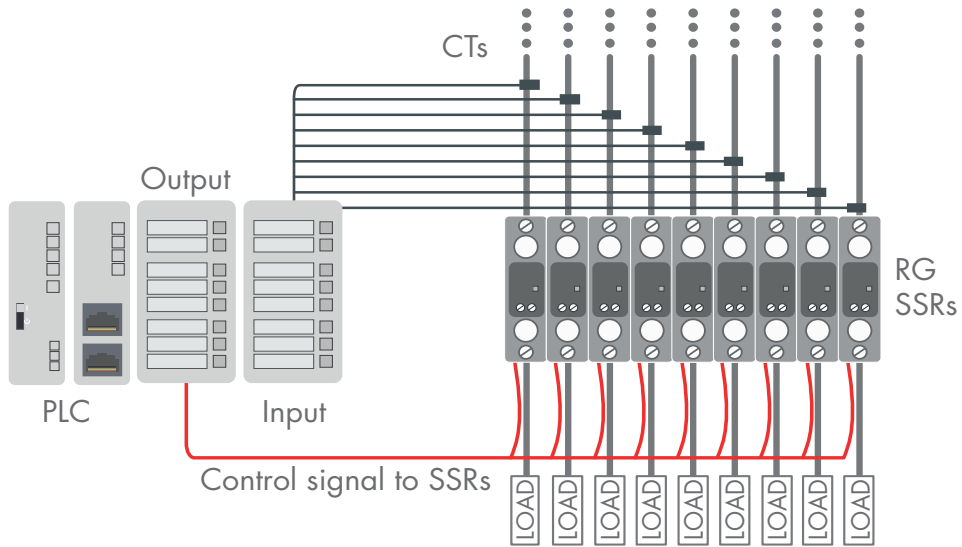

Real-time monitoring and load switching with the NRG

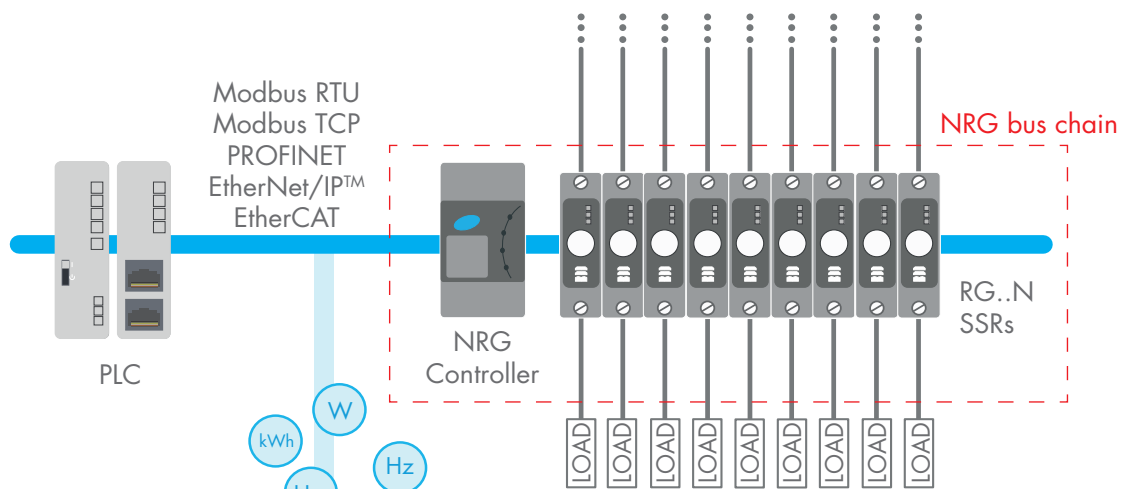

- Current Transformers (CTs) redundant
- Reduced Output modules
- Reduced Input modules
- Faster machine integration

Richer real-time data 

Optimised system cost 

NRG series

Features

Diagnostics available with the NRG

If a failure occurs, it may not be possible for the automated process to maintain the set temperature profile. Quality of goods being produced is compromised and the machine must be shut down. Machine downtime related to these failures can be eliminated or reduced by utilizing NRG parameters associated to the status of the solid state relay and other relevant accessible data.

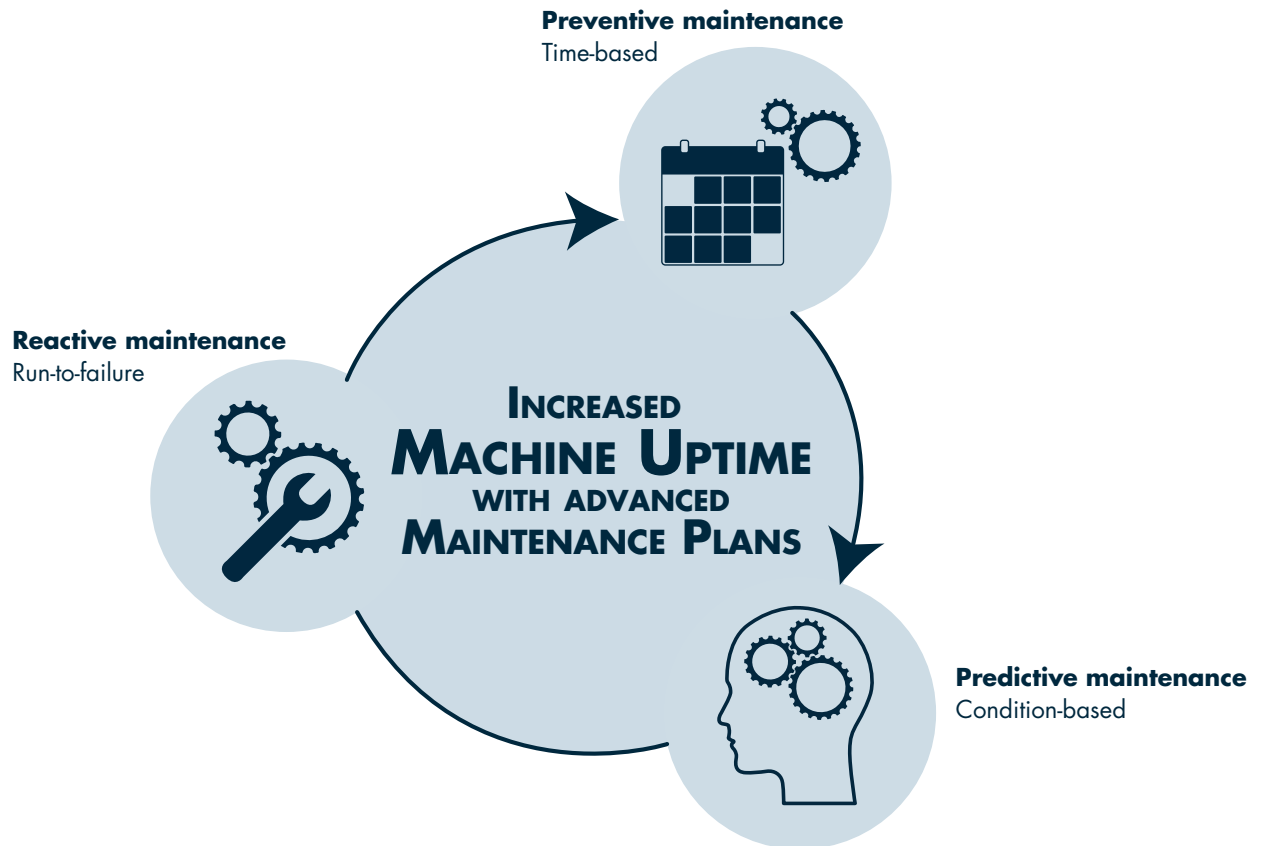

Reactive maintenance

To cater for sudden unpredictable failures, the NRG solid state relays are equipped with a number of alarms that monitor the system, the load, the SSR and also the communication system. These include:

- Load loss
- Mains loss
- SSR short circuit
- SSR open circuit
- Overtemperature
- SSR internal error
- Communication error

Preventive maintenance

The NRG solid state relays also offers a number of alarms to track system parameters which land themselves well into an efficient machine preventive maintenance plan. Such information includes:

- Current out of range
- Voltage out of range
- Frequency out of range
- Over temperature pre-warning
- Load running hours
- SSR running hours

Predictive maintenance

A possible way to predict a heater failure is through the change in resistance over its lifetime. With the NRG it is possible to continuously monitor the heater resistance by using accessible current and voltage measurements from the solid state relay and alert the machine controller if the measured resistance deviation is out of the set bounds via the

- Load Deviation alarm

The reference voltage and current to be used for the resistance monitoring can be recorded automatically via a 'TEACH' command and stored in the solid state relay

Selectable switching modes

The various NRG switching modes are selectable via the communication interface. The ON/OFF mode is a direct replacement of the PLC output modules whereby minimal changes are required to the temperature control algorithm when replacing standard solid state relays. NRG solid state relays can also be controlled externally via an input terminal. Various power control modes are also available for all application needs, eliminating the need for the output to be pulse width modulated.

Burst switching

Burst switching offers the flexibility to change the switching timebase according to the application requirements. The percentage ON time is the portion of the timebase that the SSR will be ON. The switching resolution depends on the selected timebase. Burst switching mitigates harmonics / emissions.

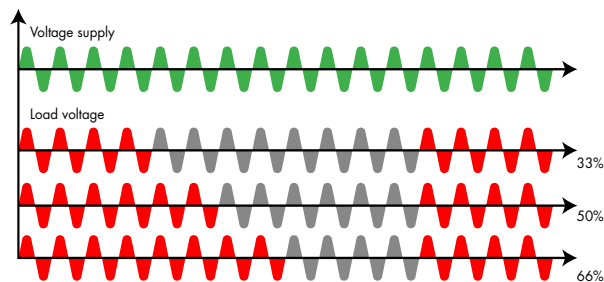

Distributed full cycle switching

Distributed full cycle switching mode works with a fixed timebase whereby the % control level from the PLC translates to an even distribution of ON cycles over the time base. Distributing ON cycles results in less thermal overshoots which can be detrimental to the lifetime of both the heater and the SSR.

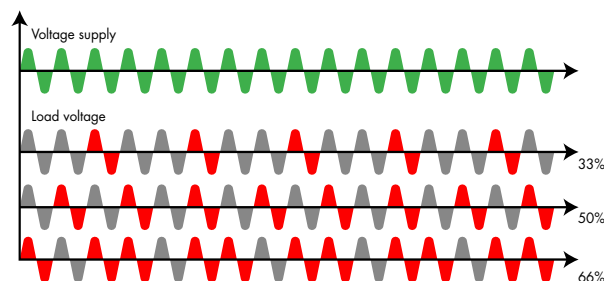

Advanced full cycle switching

Utilising the same principle as Distributed switching, the Advanced full cycle switching mode distributes half cycles evenly according to the % control level from the PLC. This switching mode is ideal to reduce visual flickering synonymous with infrared heaters.

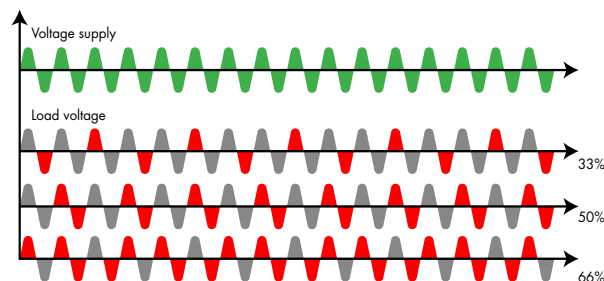

Phase angle switching

Phase angle switching delivers the power to the load by controlling the thyristor firing over each half mains cycle. Phase angle is widely used due to its precise resolution of power. Despite the higher level of harmonics and electromagnetic disturbances generated vs. other switching modes, phase angle is the only switching mode that completely eliminates visual flickering of infrared heaters.

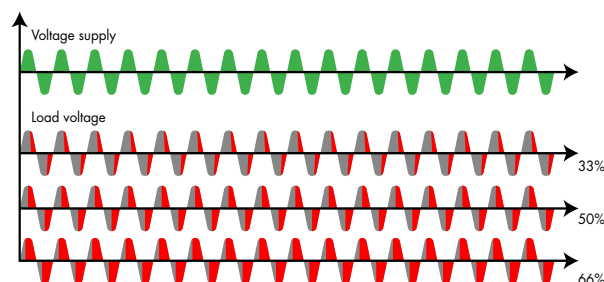

Soft starting

Soft start ramping limits the inrush current of low cold resistance heaters. The soft starting function can be applied either via a settable time period or via a settable current limit and can be utilised with all switching modes.

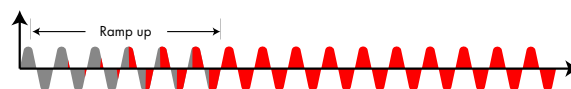

NRG series

Overview

Product structure

NRG Solid State Relay

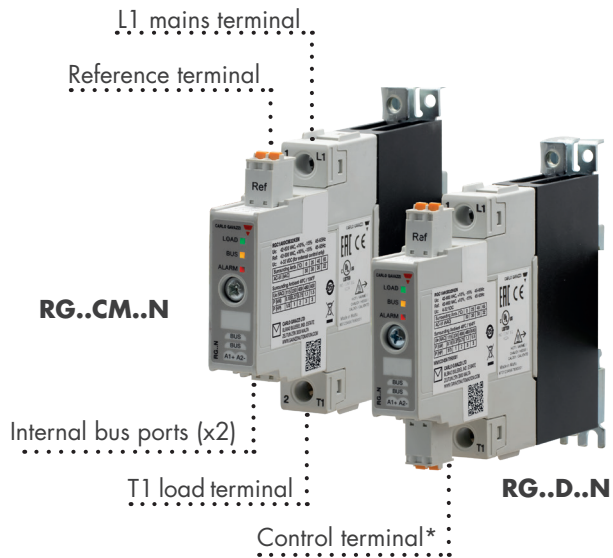

NRG Controller

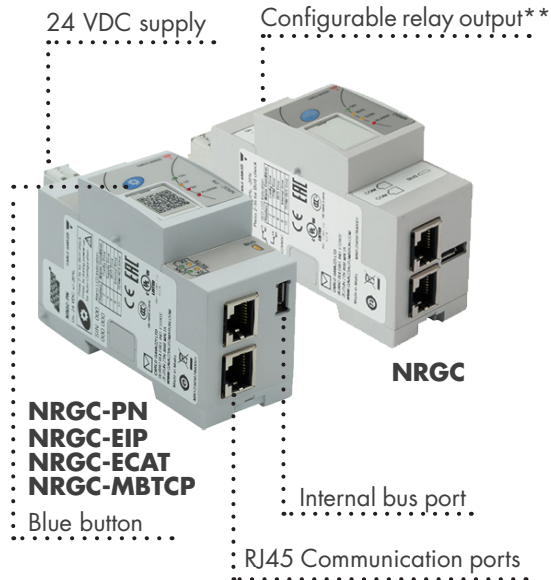

The heatsink is integrated in the RGC version only

* Available with RG..D..N only

** NRGC only

Dimensions: Refer to Selection guide

Dimensions (W x H x D mm) : 36 x 108 x 64

NRG bus chain possible combinations

Modbus	PROFINET	EtherNet/IP	EtherCAT
<p>NRG Controller</p> <p>NRGC (RTU) NRGC-MBTCP (TCP)</p>	<p>NRG Controller</p> <p>NRGC-PN</p>	<p>NRG Controller</p> <p>NRGC-EIP</p>	<p>NRG Controller</p> <p>NRGC-ECAT</p>
<p>NRG Solid State Relay</p> <p>RG..CM..N (max. 32) RG..D..N (max. 48)*</p>	<p>NRG Solid State Relay</p> <p>RG..CM..N (max. 32)</p>	<p>NRG Solid State Relay</p> <p>RG..CM..N (max. 32)</p>	<p>NRG Solid State Relay</p> <p>RG..CM..N (max. 32)</p>
<p>*for NRGC only</p>	<p>PROFIBUS • PROFINET</p>		

Selection guide

NRG Solid State Relay

Switching	External control	•	•	
	Switching via communication		•	•
	ON / OFF		•	•
	Distributed full cycle		•	•
	Advanced full cycle		•	•
	Phase angle			•
	Soft start			•
Diagnostics	Voltage compensation			•
	Load deviation monitoring		•	•
	Load loss alarm	•	•	•
	System diagnostics	•	•	•
	SSR diagnostics	•	•	•
	Parameters out of range	•	•	•
Measurement	Over temperature protection	•	•	•
	Current measurement (A)	•	•	•
	Voltage measurement (V)	•	•	•
	Frequency measurement (Hz)	•	•	•
	Power measurement (W, VA)	•	•	•
	SSR running hours (Hours)	•	•	•
	Load running hours (Hours)		•	•
References	Energy consumption (kWh)	•	•	•
	Versions w. integrated heatsink			
	25 AAC @ 40°C	RG1A60D25KEN	RG1A60CM25KEN	RG1P60CM25KEN
	32 AAC @ 40°C	RG1A60D32KEN	RG1A60CM32KEN	RG1P60CM32KEN
	37 AAC @ 40°C	RG1A60D32GEN	RG1A60CM32GEN	RG1P60CM32GEN
	43 AAC @ 40°C	RG1A60D42GEN	RG1A60CM42GEN	RG1P60CM42GEN
	65 AAC @ 40°C	RG1A60D62GEN	RG1A60CM62GEN	RG1P60CM62GEN
	Versions without heatsink			
	50 AAC	RG51A60D50KEN	RG51A60CM50KEN	RG51P60CM50KEN
	90 AAC	RG51A60D92XEN	RG51A60CM92XEN	RG51P60CM92XEN
BUS	Max. number of RG..Ns on bus chain	48	32	32
	Max. rated voltage	660 VAC	660 VAC	660 VAC
Specifications	I ² t rating	up to 18000 A ² s	up to 18000 A ² s	up to 18000A ² s
	Dimensions (W x H x D mm)			
	RG1..25, 32	17.8 x 110 x 134	17.8 x 110 x 134	17.8 x 110 x 134
	RG1..42	35 x 110 x 172	35 x 110 x 172	35 x 110 x 172
	RG1..62	70 x 110 x 172	70 x 110 x 172	70 x 110 x 172
RG5..	17.8 x 90 x 82	17.8 x 90 x 82	17.8 x 90 x 82	
Certifications	CE - cULus - UR - CSA - EAC - UKCA - CCC			

NRG Controller

Features	Communication interface	Modbus RTU	PROFINET	EtherNet/IP™	EtherCAT	Modbus TCP
	Power supply	24 VDC	24 VDC	24 VDC	24 VDC	24 VDC
	Auxiliary digital output (EMR)	•				
	References	NRGC	NRGC-PN	NRGC-EIP	NRGC-ECAT	NRGC-MBTCP
Certifications	CE - cULus - EAC - UKCA					

NRG Internal Bus cables

References	Cable length
	10 cm
	75 cm
	150 cm
	350 cm
	500 cm

XEN = KEN for screw power terminals

XEN = GEN for box clamp power terminals

*Packed by 4 pcs. Further details are available on online datasheets at www.gavazziautomation.com

CARLO GAVAZZI Automation Components. Specifications are subject to change without notice. Illustrations are for example only.

OUR SALES NETWORK IN EUROPE

AUSTRIA

Carlo Gavazzi GmbH
Ketzergasse 374,
A-1230 Wien
Tel: +43 1 888 4112
Fax: +43 1 889 10 53
office@carlogavazzi.at

BELGIUM

Carlo Gavazzi NV/SA
Mechelsesteenweg 311,
B-1800 Vilvoorde
Tel: +32 2 257 4120
sales@carlogavazzi.be

DENMARK

Carlo Gavazzi Handel A/S
Over Hadstensevej 40,
DK-8370 Hadsten
Tel: +45 89 60 6100
Fax: +45 86 98 15 30
handel@gavazzi.dk

FINLAND

Carlo Gavazzi OY AB
Ahventie, 4 B
FI-02170 Espoo
Tel: +358 9 756 2000
myynti@gavazzi.fi

FRANCE

Carlo Gavazzi Sarl
Zac de Paris Nord II, 69, rue de la Belle Etoile,
F-95956 Roissy CDG Cedex
Tel: +33 1 49 38 98 60
Fax: +33 1 48 63 27 43
french.team@carlogavazzi.fr

GERMANY

Carlo Gavazzi GmbH
Pfnorstr. 10-14
D-64293 Darmstadt
Tel: +49 6151 81000
Fax: +49 6151 81 00 40
info@gavazzi.de

GREAT BRITAIN

Carlo Gavazzi UK Ltd
4.4 Frimley Business Park,
Frimley, Camberley, Surrey GU16 7SG
Tel: +44 1 276 854 110
Fax: +44 1 276 682 140
sales@carlogavazzi.co.uk

ITALY

Carlo Gavazzi SpA
Via Milano, 13,
I-20045 Lainate
Tel: +39 02 931 761
Fax: +39 02 931 763 01
info@gavazziacbu.it

NETHERLANDS

Carlo Gavazzi BV
Wijkermeerweg 23,
NL-1948 NT Beverwijk
Tel: +31 251 22 9345
Fax: +31 251 22 60 55
info@carlogavazzi.nl

NORWAY

Carlo Gavazzi AS
Melkeveien 13,
N-3919 Parsgrunn
Tel: +47 35 93 0800
Fax: +47 35 93 08 01
posti@gavazzi.no

PORTUGAL

Carlo Gavazzi Lda
Rua dos Jerónimos 38-B,
P-1400-212 Lisboa
Tel: +351 21 361 7060
Fax: +351 21 362 13 73
carlogavazzi@carlogavazzi.pt

SPAIN

Carlo Gavazzi SA
Avda. Iparraguirre, 80-82,
E-48940 Leioa (Bizkaia)
Tel: +34 94 480 4037
Fax: +34 94 431 6081
gavazzi@gavazzi.es

SWEDEN

Carlo Gavazzi AB
V:a Kyrkogatan 1,
S-652 24 Karlstad
Tel: +46 54 85 1125
Fax: +46 54 85 11 77
info@carlogavazzi.se

SWITZERLAND

Carlo Gavazzi AG
Verkauf Schweiz/Vente Suisse
Sumpfstrasse 3,
CH-6312 Steinhausen
Tel: +41 41 747 4535
Fax: +41 41 740 45 40
info@carlogavazzi.ch

OUR SALES NETWORK IN THE AMERICAS

USA

Carlo Gavazzi Inc.
750 Hastings Lane,
Buffalo Grove, IL 60089, USA
Tel: +1 847 465 6100
Fax: +1 847 465 7373
sales@carlogavazzi.com

CANADA

Carlo Gavazzi Inc.
2660 Meadowvale Boulevard,
Mississauga, ON L5N 6M6, Canada
Tel: +1 905 542 0979
Fax: +1 905 542 22 48
gavazzi@carlogavazzi.com

MEXICO

Carlo Gavazzi Mexico S.A. de C.V.
Circuito Puericultores 22, Ciudad Satelite
Naucalpan de Juarez, Edo Mex. CP 53100
Mexico
T +52 55 5373 7042
F +52 55 5373 7042
mexicosales@carlogavazzi.com

BRAZIL

Carlo Gavazzi Automação Ltda.
Av. Francisco Matarazzo, 1752
Conj 2108 - Barra Funda - São Paulo/SP
Tel: +55 11 3052 0832
Fax: +55 11 3057 1753
info@carlogavazzi.com.br

OUR SALES NETWORK IN ASIA AND PACIFIC

SINGAPORE

Carlo Gavazzi Automation Singapore Pte. Ltd.
61 Tai Seng Avenue #05-06
Print Media Hub @ Paya Lebar iPark
Singapore 534167
Tel: +65 67 466 990
Fax: +65 67 461 980
info@carlogavazzi.com.sg

MALAYSIA

Carlo Gavazzi Automation (M) SDN. BHD.
D12-06-G, Block D12,
Pusat Perdagangan Dana 1,
Jalan PJU 1A/46, 47301 Petaling Jaya,
Selangor, Malaysia.
Tel: +60 3 7842 7299
Fax: +60 3 7842 7399
sales@gavazzi-asia.com

CHINA

Carlo Gavazzi Automation
(China) Co. Ltd.
Unit 2308, 23/F.,
News Building, Block 1, 1002
Middle Shennan Zhong Road,
Shenzhen, China
Tel: +86 755 83699500
Fax: +86 755 83699300
sales@carlogavazzi.cn

HONG KONG

Carlo Gavazzi Automation
Hong Kong Ltd.
Unit No. 16 on 25th Floor, One Midtown,
No. 11 Hoi Shing Road, Tsuen Wan,
New Territories, Hong Kong
Tel: +852 26261332 / 26261333
Fax: +852 26261316

TAIWAN

Branch of Carlo Gavazzi Automation
Singapore Pte. Ltd.
12F-3, No. 530, Yingcai Rd., West Dist.,
403518 - Taichung City
Taiwan, China
Tel: +886 4 2258 4001
Fax: +886 4 2258 4002

OUR COMPETENCE CENTRES AND PRODUCTION SITES

DENMARK

Carlo Gavazzi Industri A/S
Hadsten

MALTA

Carlo Gavazzi Ltd
Zejtun

ITALY

Carlo Gavazzi Controls SpA
Belluno

LITHUANIA

Uab Carlo Gavazzi Industri Kaunas
Kaunas

CHINA

Carlo Gavazzi Automation (Kunshan) Co., Ltd.
Kunshan

HEADQUARTERS

Carlo Gavazzi Automation SpA
Via Milano, 13
I-20045 - Lainate (MI) - ITALY
Tel: +39 02 931 761
info@gavazziautomation.com

Energy to Components!

www.gavazziautomation.com